

- S1200 - 1.20x1.20 m
- S1700 - 1.70x1.70 m

S1200

 39.6 m → 50 m

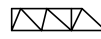
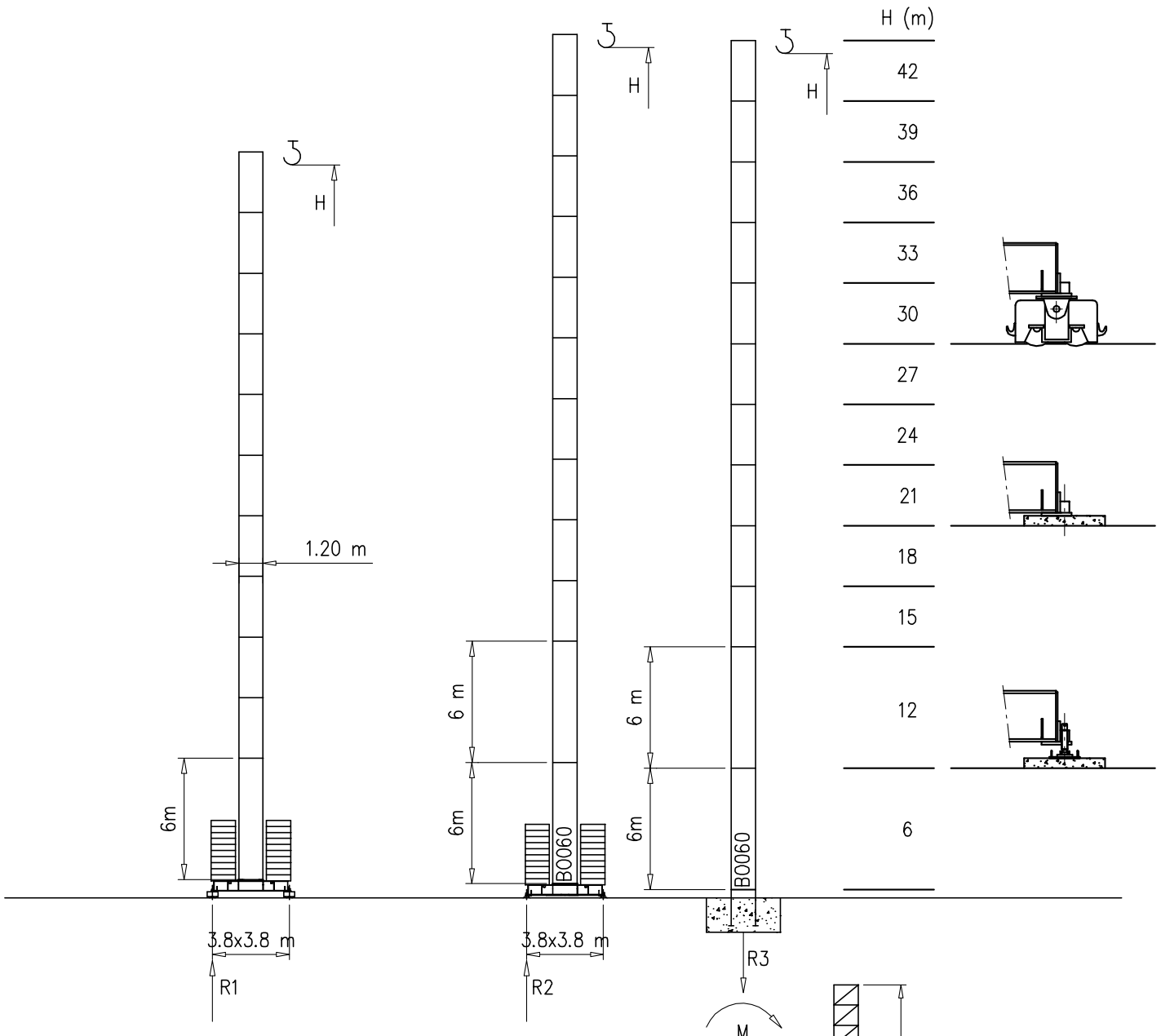

H=37-42 m		H=24-36 m		H=0-23 m	
R1	55 t	R1	55 t	R1	45 t
R2	69 t	R2	55 t	R2	43 t
R3	44 t	R3	37 t	R3	39 t
M	185 tm	M	116 tm	M	101 tm

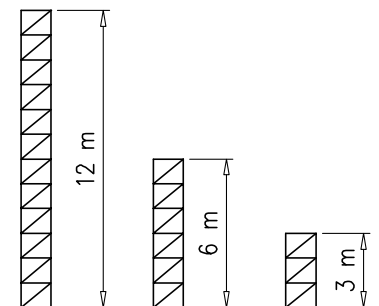

Peso zavorra – Ballast weight – Poids du lest – Ballastgewicht – Peso de lastre

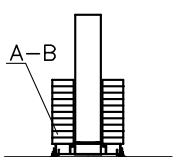
	3.8x3.8	H	n°	Tot.
		0-23 m	18 B	54000 kg
		24-36 m	20 B	60000 kg
		37-42 m	24 B	72000 kg
	3.2x3.2	H	n°	Tot.
		0-27 m	18 A	54000 kg

	A	B
L	3.6m	4.0m
k	0.3m	0.19m
d	1.15m	1.2m

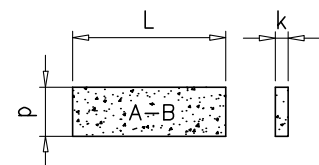

Torre/Reazioni - Masts/Reactions - Mat/Réactions - Maste/Eckdrücke - Mástil/Reacciones - Tramo/Reacções

S1700

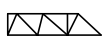
 39.6 m → 50 m

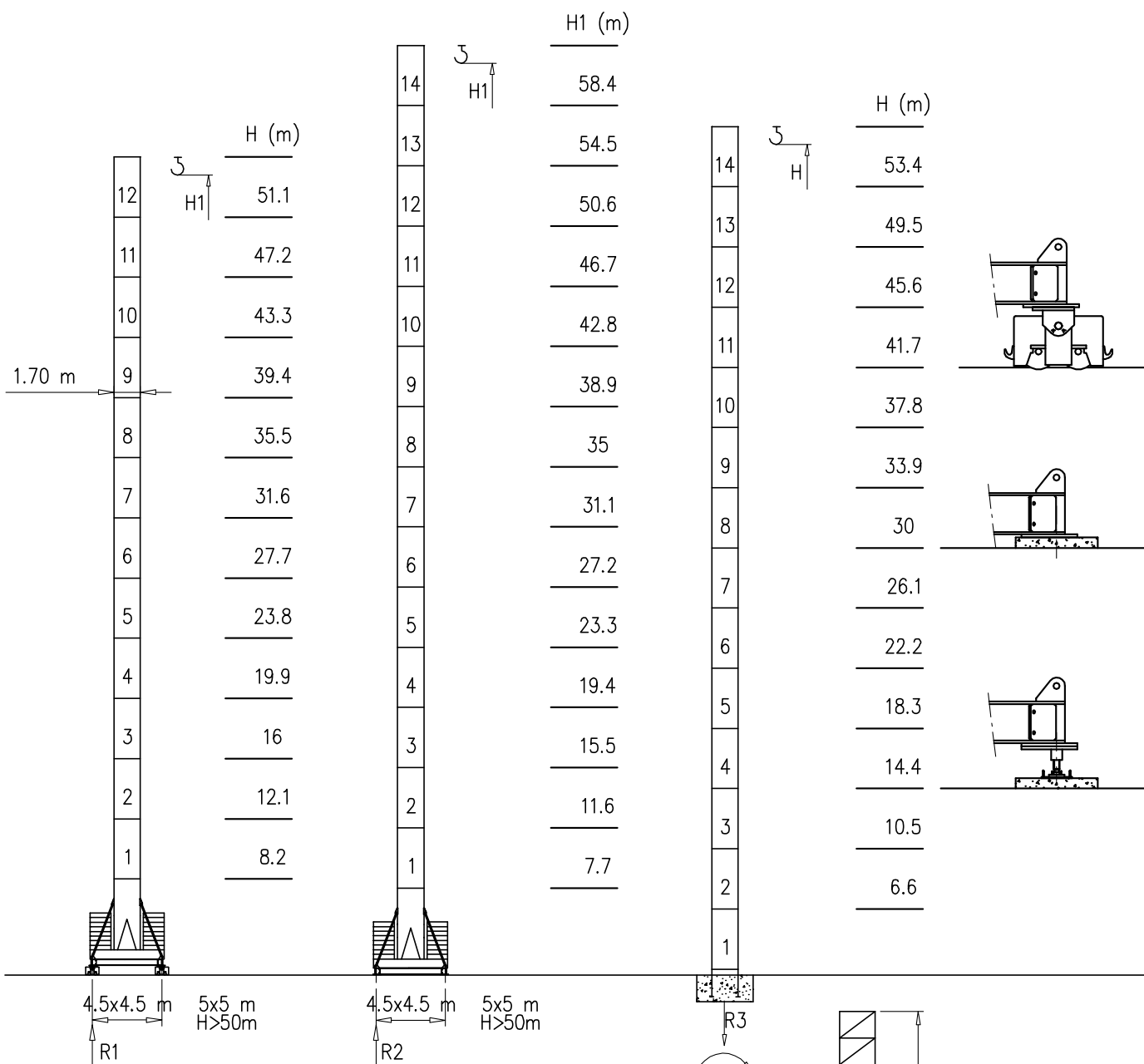

H=46-58 m		H=36-45 m		H=0-35 m	
R1	106 t	R1	72 t	R1	65 t
R2	106 t	R2	72 t	R2	65 t
R3	95 t	R3	61 t	R3	54 t
M	336 tm	M	194 tm	M	156 tm

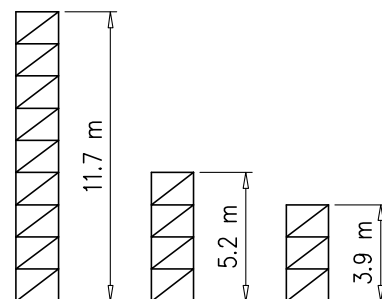





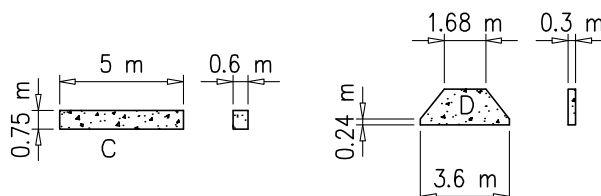



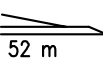

Peso zavorra - Ballast weight - Poids du lest - Ballastgewicht - Peso de lastre

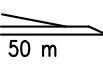
H	n°	Tot.
0-35 m	2C+ 18D	60800 kg
36-45 m	2C+ 22D	72000 kg
46-58 m	2C+ 32D	105000 kg

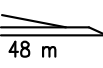

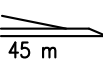

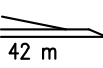

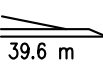



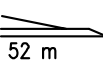

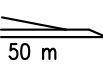
Curve di carico – Courbes de charges – Load diagrams – LastKurven – Curvas de cargas

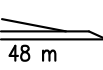

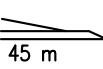

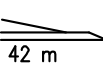

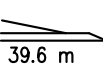

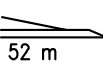

Pmax 3000 kg

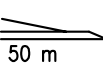
	14400 kg		2	22	24	26	28	30	32	34	36	38	40	42	44	46	48	52	m
			3000	3000	2790	2550	2350	2180	2020	1890	1770	1660	1570	1480	1400	1330	1260	1000	kg
	14400 kg		2	22	24	26	28	30	32	34	36	38	40	42	44	46	48	50	m
			3000	3000	2790	2550	2350	2180	2020	1890	1770	1660	1570	1480	1400	1330	1260	1200	kg
	14400 kg		2	2	26	28	30	32	34	36	38	40	42	44	46	48	m		
			3000	3000	3000	2760	2560	2380	2230	2090	1960	1850	1750	1660	1580	1500	kg		
	14400 kg		2	2	26	28	30	32	34	36	38	40	42	44	45	m			
			3000	3000	3000	2730	2530	2360	2200	2070	1940	1830	1730	1640	1600	kg			
	12000 kg		2	2	26	28	30	32	34	36	38	40	42	m					
			3000	3000	3000	2830	2630	2450	2290	2190	2020	1900	1800	kg					
	9600 kg		2	2	27	28	30	32	34	36	38	39.6	m						
			3000	3000	3000	2890	2680	2500	2330	2190	2060	2000	kg						

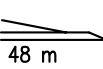
Pmax 6000/3000 kg

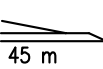
	14400 kg		2	13	16	18	20	22	24	26	28	30	32	34	36	38	40	42	44	46	48	52	m
			6000	6000	4310	3810	3400	3000	2790	2550	2350	2180	2020	1890	1770	1660	1570	1480	1400	1330	1260	1000	kg
	14400 kg		2	13	16	18	20	22	24	26	28	30	32	34	36	38	40	42	44	46	48	50	m
			6000	6000	4310	3810	3400	3000	2790	2550	2350	2180	2020	1890	1770	1660	1570	1480	1400	1330	1260	1200	kg
	14400 kg		2	15	16	18	20	22	24	26	28	30	32	34	36	38	40	42	44	46	48	m	
			6000	6000	5300	4440	3970	3590	3760	3000	2760	2560	2380	2230	2090	1960	1850	1750	1660	1580	1500	kg	
	14400 kg		2	15	16	18	20	22	24	26	28	30	32	34	36	38	40	42	44	45	m		
			6000	6000	5200	4400	3930	3550	3230	3000	2730	2530	2360	2200	2070	1940	1830	1730	1640	1600	kg		
	12000 kg		2	15	16	18	20	22	24	26	28	30	32	34	36	38	40	42	m				
			6000	6000	5400	4550	4070	3680	3350	3000	2830	2630	2450	2290	2190	2020	1900	1800	kg				
	9600 kg		2	15	16	18	20	22	24	26	28	30	32	34	36	38	39.6	m					
			6000	6000	5300	4640	4150	3750	3420	3130	2890	2680	2500	2330	2190	2060	2000	kg					

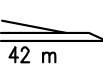
Pmax 6000 kg

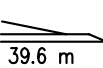
	14400 kg		2	13	16	18	20	22	24	26	28	30	32	34	36	38	40	42	44	46	48	52	m
			6000	6000	4310	3810	3400	3000	2790	2550	2350	2180	2020	1890	1770	1660	1570	1480	1400	1330	1260	1000	kg
	14400 kg		2	13	16	18	20	22	24	26	28	30	32	34	36	38	40	42	44	46	48	50	m
			6000	6000	4310	3810	3400	3000	2790	2550	2350	2180	2020	1890	1770	1660	1570	1480	1400	1330	1260	1200	kg
	14400 kg		2	15	16	18	20	22	24	26	28	30	32	34	36	38	40	42	44	46	48	m	
			6000	6000	5300	4440	3970	3590	3760	3000	2760	2560	2380	2230	2090	1960	1850	1750	1660	1580	1500	kg	
	14400 kg		2	15	16	18	20	22	24	26	28	30	32	34	36	38	40	42	44	45	m		
			6000	6000	5200	4400	3930	3550	3230	3000	2730	2530	2360	2200	2070	1940	1830	1730	1640	1600	kg		
	12000 kg		2	15	16	18	20	22	24	26	28	30	32	34	36	38	40	42	m				
			6000	6000	5400	4550	4070	3680	3350	3000	2830	2630	2450	2290	2190	2020	1900	1800	kg				
	9600 kg		2	15	16	18	20	22	24	26	28	30	32	34	36	38	39.6	m					
			6000	6000	5300	4640	4150	3750	3420	3130	2890	2680	2500	2330	2190	2060	2000	kg					







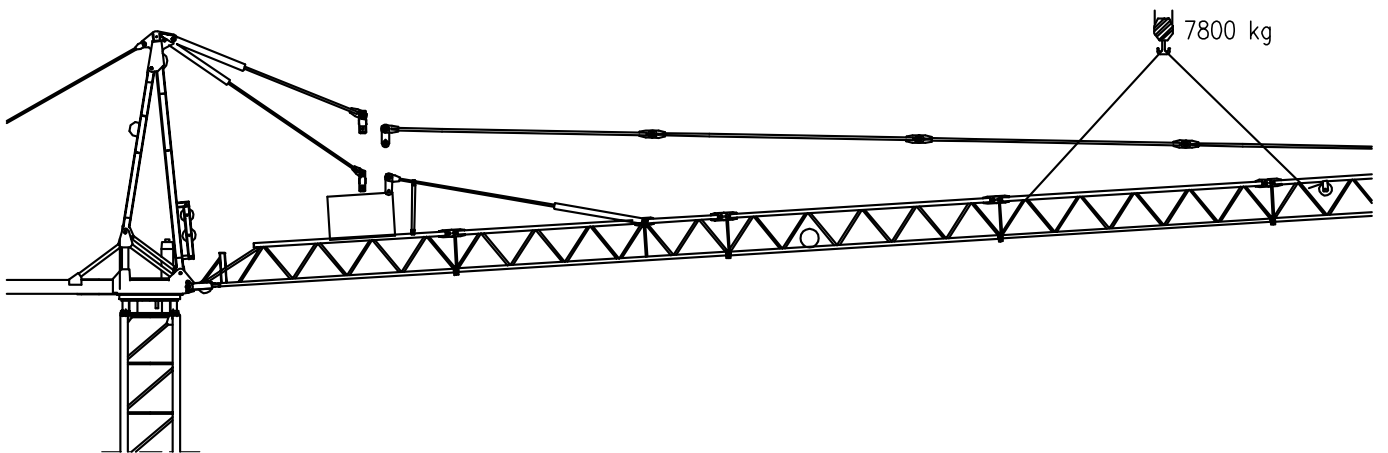
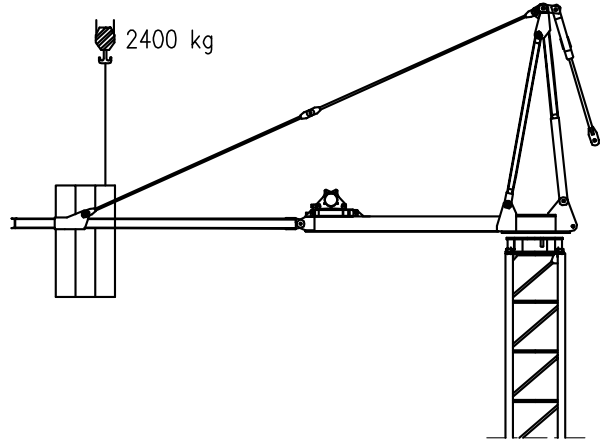
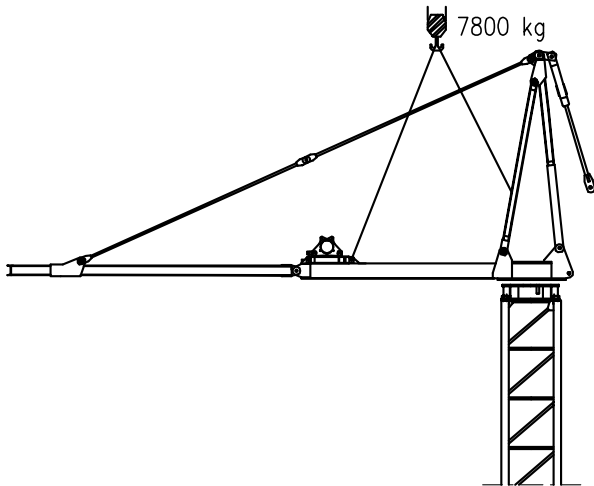
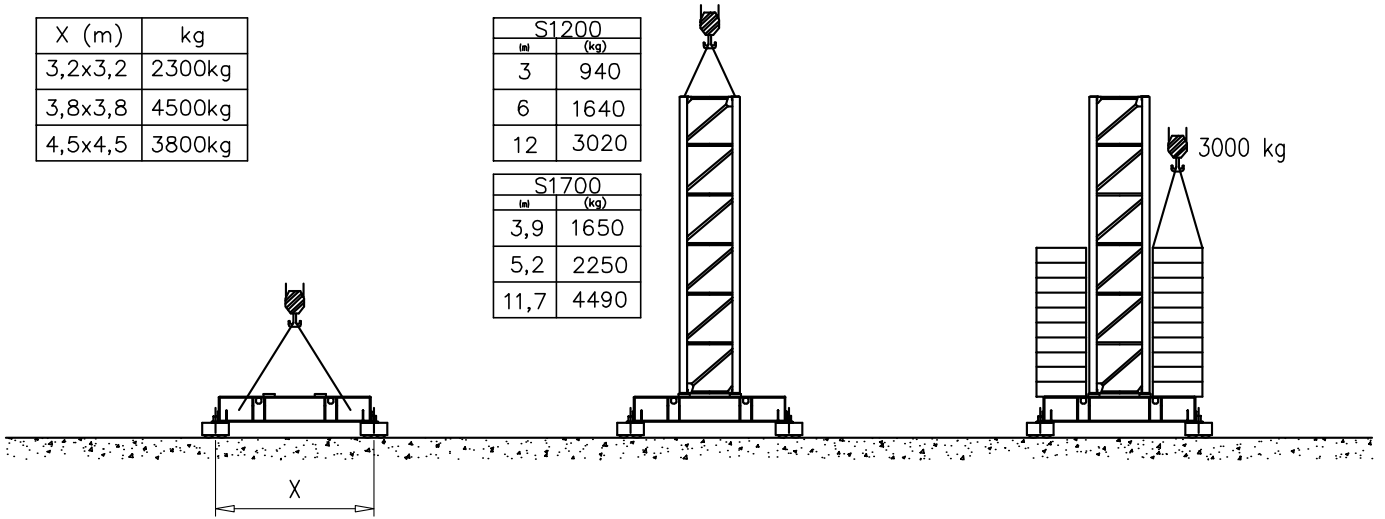





X (m)	kg
3,2x3,2	2300kg
3,8x3,8	4500kg
4,5x4,5	3800kg

S1200	
tel	(kg)
3	940
6	1640
12	3020

S1700	
tel	(kg)
3,9	1650
5,2	2250
11,7	4490

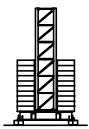

Meccanismi – Mechanisms – Mécanismes – Antriebe – Mecanismos

Sollevamento S20.40 e V20.40 Hoisting Levage Heben Elevaciòn Elevaçao			1a	4 m/min	3000 kg	14.7 kW	S20.40 32 kVA
			2a	20 m/min	3000 kg		
			3a	40 m/min	1500 kg		
			1a	2 m/min	6000 kg		V20.40 28 kVA
			2a	10 m/min	6000 kg		
			3a	20 m/min	3000 kg		
Sollevamento S2560 e V25.60 Hoisting Levage Heben Elevaciòn Elevaçao			1a	7 m/min	3000 kg	18.5 kW	S25.60 38kVA
			2a	28 m/min	3000 kg		
			3a	56 m/min	1500 kg		
			1a	3.5 m/min	6000 kg		V25.60 33 kVA
			2a	14 m/min	6000 kg		
			3a	28 m/min	3000 kg		
Sollevamento V45.60 Hoisting Levage Heben Elevaciòn Elevaçao			1a	2 m/min	6000 kg	33 kW	V45.60 50 kVA
			2a	20 m/min	6000 kg		
			3a	31 m/min	5000 kg		
			4a	46 m/min	3200 kg		
			5a	60 m/min	2500 kg		
Carrello Trolleying Distribution Katzfahren Distribuciòn Distribuiçao			1a	OP 5 m/min	6000 kg	3 kW	Potenza elettrica necessaria Puissance électrique nécessaire Necessary electric power Anschlusswert – Potencia
			2a	25 m/min	6000 kg		
			3a	50 m/min	3000 kg		
Rotazione Slewing Orientation Schwenken Orientaciòn Rotaçao			1a	0 → 0.2	giri/min	4.4 kW @ 1200rpm n° 2 x 2.2 kW	
			2a	0 → 0.6	tr/min		
			3a	0 → 0.9	rp/min		
Traslazione Travelling Translation Kranfahren Traslaciòn Translaçao			1a	OP 0 → 5	3.7 kW		
			2a	0 → 20			

Rete elettrica – Réseau – Mains supply – Netzstrom – Red – Rede electrica	400V – 50 Hz
---	--------------

 FMgru s.r.l. via Emilia 11–29010 Pontenure PC ITALY tel. 0523/510446 ric.aut. fax 0523/510365 www.fmgru.com e-mail: info@fmgru.com	FEM 1.001 2000/14/CE	
---	-------------------------	--



Documento commerciale non contrattuale
Per tutte le informazioni tecniche riferirsi
alle corrispondenti istruzioni

Unverbindliches Vertriebsdokument.
Für technische Informationen, siehe die
entsprechenden Anweisungen.

This commercial document is not legally
binding. For any technical information, please
refer to the corresponding instructions.

Documento comercial no contractual
Para cualquier información técnica,
ver la noticia correspondiente.

Code: 15ICA37CB0A0			
Ed.	Data	Rev.	Data
1	05.06.03	1	02.12.05